

Flashings and Trims

Ideal Roofing flashings and trims come in 10 ft. lengths and are available in plain galvanized, galvalume and in galvanized pre-painted steel in over 30 attractive colours. Standard gauge thickness used is 30 ga. (.015") but our flashings and trims shown in this brochure are standard but can be modified to customer specifications.

ROOFING FLASHINGS

NOTE: USE THE #205 WALL FLASHING AND THE #210 COTTAGE ROOF CAP FOR THE "SECURITY" RIB, "POCKET" RIB, "AMERI-CANA" PANEL AND "FUNDY" PANEL.

#201

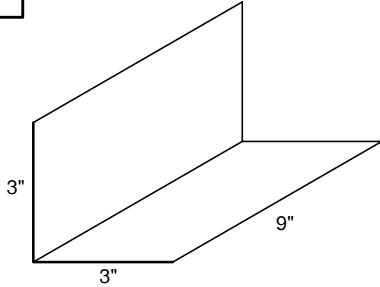

STEP FLASHING (6" X 9")
(50 PCS PER BUNDLE) (MIXED COLOURS)

#203

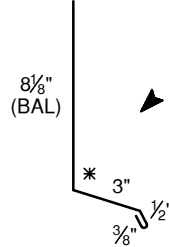

LARGE WALL OR CHIMNEY FLASHING TYPE S
(12" GIRTH) * SPECIFY PITCH

#205

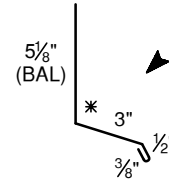

WALL FLASHING TYPE S
(9" GIRTH) * SPECIFY PITCH

#206

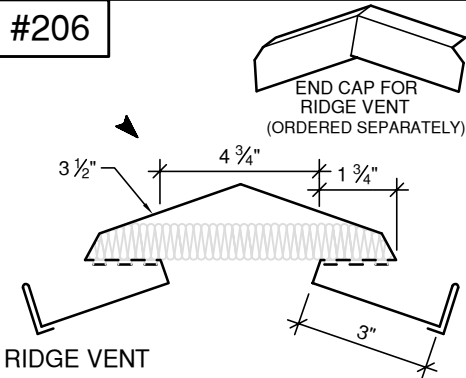

RIDGE VENT

#207

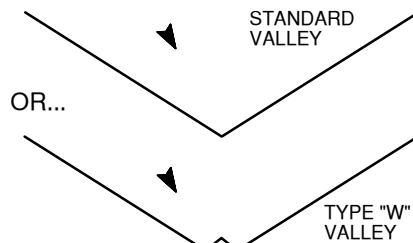

VALLEY 18", 24" AND 36"

#208

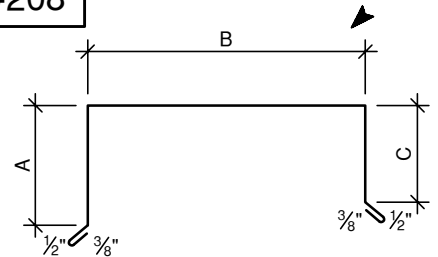

CAP FLASHING
(A+B+C+1 1/4" = GIRTH)

#209

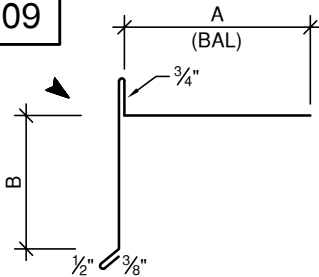

GRAVEL STOP
(A+B+2 3/8" = GIRTH)

#210

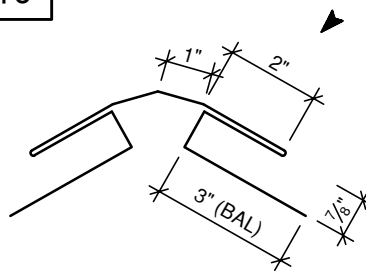

COTTAGE ROOF CAP
(18" GIRTH)

#211

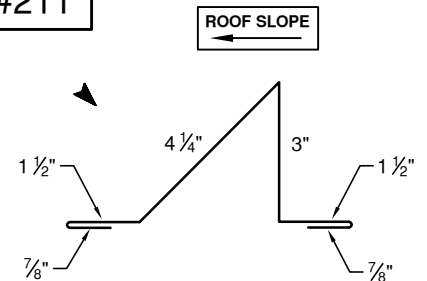

SNOW GUARD
(12" GIRTH) MINIMUM 26g (.021") RECOMMENDED

#212

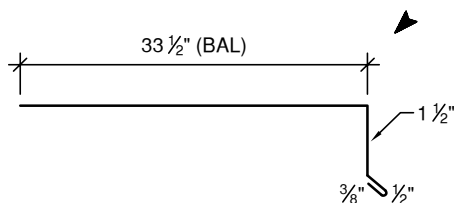

ICE APRON
(for shingles)
(36" GIRTH)

#213 TYPE 1

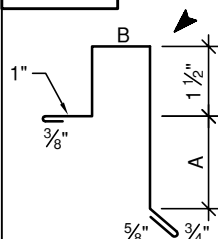

GABLE END CAP FOR "HERITAGE" PROFILE
(A+B+5 3/4" = GIRTH)

#213 TYPE 2

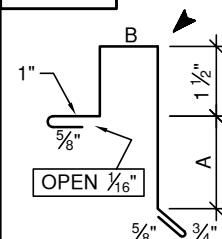

GABLE END CAP FOR "HERITAGE" PROFILE
(A+B+6" = GIRTH)

#214

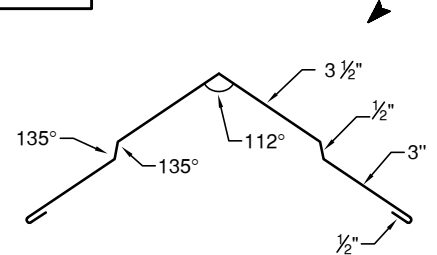

LIBERTY RIDGE CAP
(15" GIRTH)

FLASHINGS AND MOULDINGS FOR SIDING

NOTE: THE "300 SERIES" FLASHINGS & MOULDINGS MAY BE USED WITH THE FOLLOWING PROFILES.

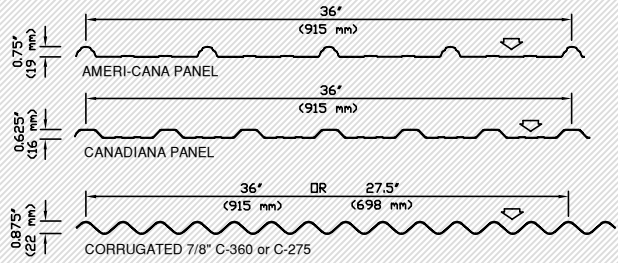
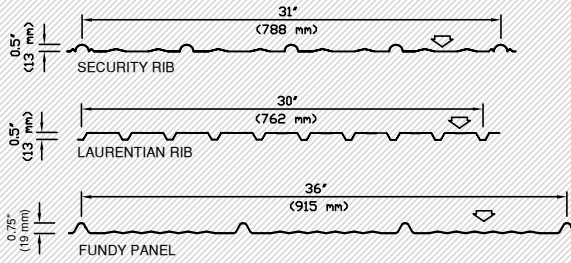

#301

X=Profile opening

- PROFILES:**
- (a) Laurentian 5/8" (X)
 - (b) Corrugated 1"
 - (c) Security 5/8"
 - (d) Ameri-Cana, Canadiana and Fundy 7/8"

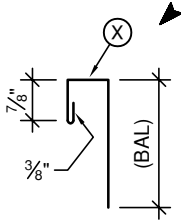

"J" TRIM
(5" GIRTH)

#302

X=Profile opening

- PROFILES:**
- (a) Laurentian 5/8" (X)
 - (b) Corrugated 1"
 - (c) Security 5/8"
 - (d) Ameri-Cana, Canadiana and Fundy 7/8"

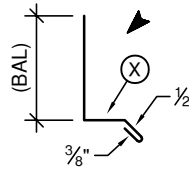

BASE FLASHING
(4" GIRTH)

#303

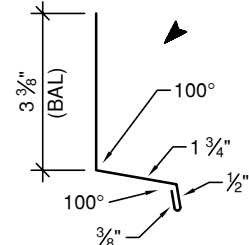

WINDOW & DOOR FLASHING
(6" GIRTH)

#304

X=Profile opening

- PROFILES:**
- (a) Laurentian 5/8" (X)
 - (b) Corrugated 1"
 - (c) Security 5/8"
 - (d) Ameri-Cana, Canadiana and Fundy 7/8"

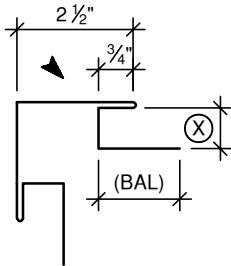

OUTSIDE CORNER
(12" GIRTH)

#305

X=Profile opening

- PROFILES:**
- (a) Laurentian 5/8" (X)
 - (b) Corrugated 1"
 - (c) Security 5/8"
 - (d) Ameri-Cana, Canadiana and Fundy 7/8"

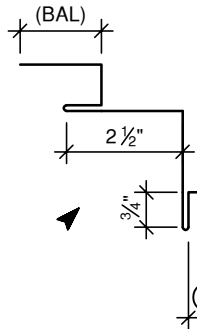

INSIDE CORNER
(12" GIRTH)

#306

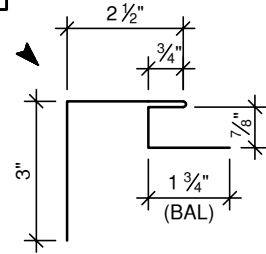

HALF CORNER
(9" GIRTH)

#307

X=Profile opening

- PROFILES:**
- (a) Laurentian 5/8" (X)
 - (b) Corrugated 1"
 - (c) Security 5/8"
 - (d) Ameri-Cana, Canadiana and Fundy 7/8"

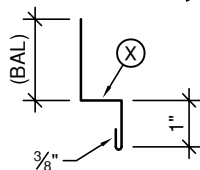

GABLE DIVIDER
(4" GIRTH)

#308

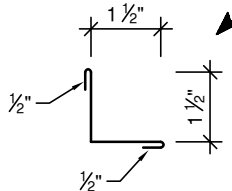

"L" TRIM
(4" GIRTH)

#309

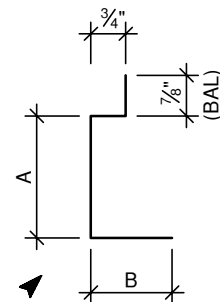

WINDOW CASING FLASHING
(A+B+1 1/8" GIRTH)

#310

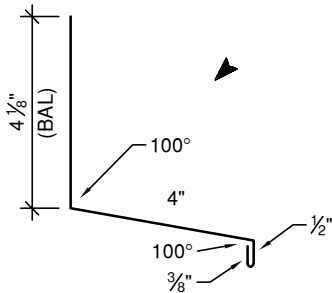

BRICK FLASHING
(9" GIRTH)

#311

X=Profile opening

- PROFILES:**
- (a) Laurentian 5/8" (X)
 - (b) Corrugated 1"
 - (c) Security 5/8"
 - (d) Ameri-Cana, Canadiana and Fundy 7/8"

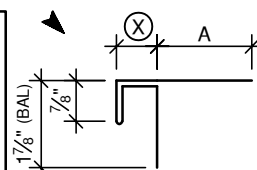

WINDOW & DOOR JAMB
(2X + A + 3 5/8" = GIRTH)

#312

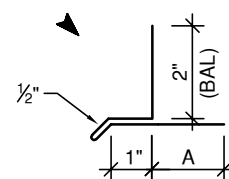

WINDOW & DOOR FLASHING
(5"+A = GIRTH)

FLASHINGS AND MOULDINGS FOR SIDING (continue)

#313

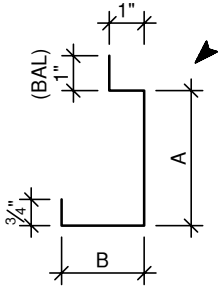

SLIDING DOOR EDGE TRIM
(A+B+2 3/4" GIRTH)

#314

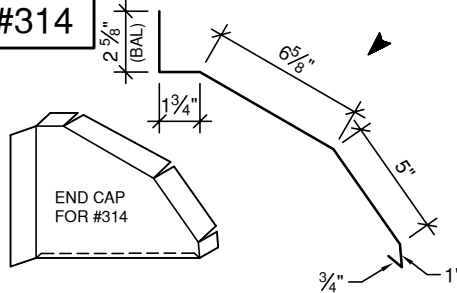

COVER FOR DOUBLE ROUND DOOR TRACK
(18" GIRTH)

#315

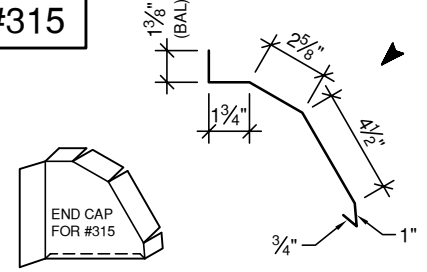

COVER FOR SINGLE ROUND DOOR TRACK
(12" GIRTH)

#316

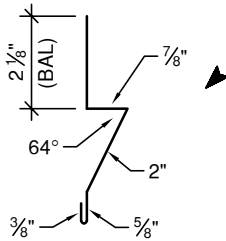

ANGLED BASE FLASHING
(6" GIRTH)

#317

X=Profile opening
Y=Profile opening

PROFILES: (X)(Y)

- (a) Laurentian 5/8"
- (b) Corrugated 1"
- (c) Security 5/8"
- (d) Ameri-Can, Canadiana and Fundy 7/8"

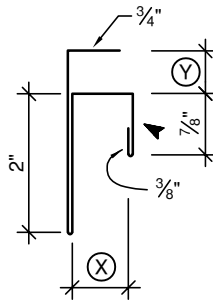

"F-J" TRIM
(X+Y+6"=GIRTH)

#318

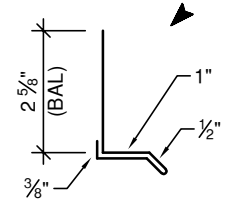

WINDOW & DOOR FLASHING
(6" GIRTH)

FLASHINGS FOR EAVES & GABLE ENDS

#401

Ⓟ VENTED AT EXTRA COST

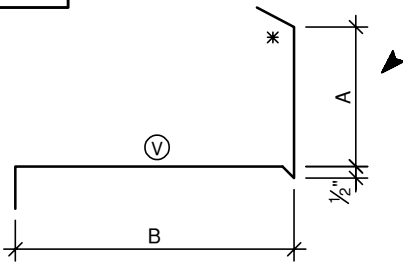

FASCIA AND SOFFIT: TYPE 1
(A+B+5" = GIRTH) * SPECIFY PITCH

#402

Ⓟ VENTED AT EXTRA COST

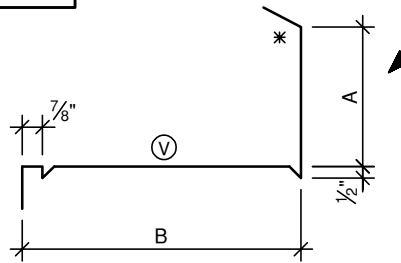

FASCIA AND SOFFIT: TYPE 1J
(A+B+5" = GIRTH) * SPECIFY PITCH

#404

Ⓟ VENTED AT EXTRA COST

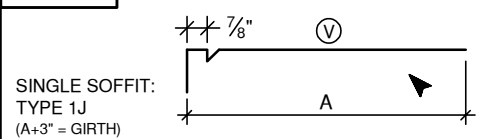

SINGLE SOFFIT: TYPE 1J
(A+3" = GIRTH)

#408

STARTER FOR SHINGLES
(5" GIRTH)

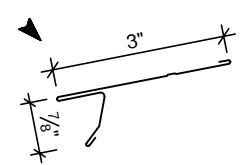

#405

Ⓟ VENTED AT EXTRA COST

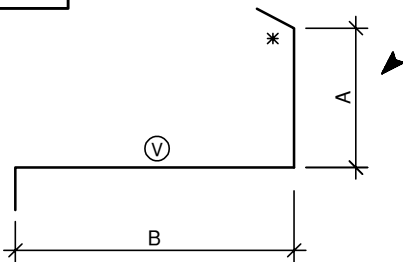

FASCIA AND SOFFIT: TYPE 2
(A+B+4" = GIRTH) * SPECIFY PITCH

#406

Ⓟ VENTED AT EXTRA COST

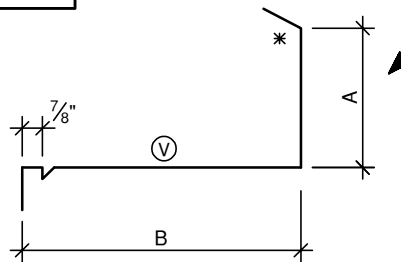

FASCIA AND SOFFIT: TYPE 2J
(A+B+5" = GIRTH) * SPECIFY PITCH

#409

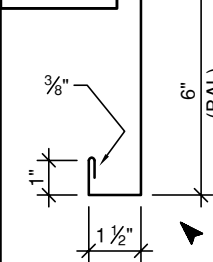

FASCIA: TYPE 1
(9" GIRTH)

#410

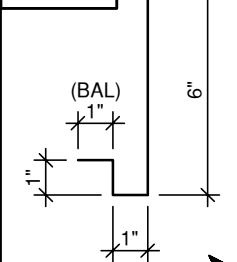

FASCIA: TYPE 2
(9" GIRTH)

#411

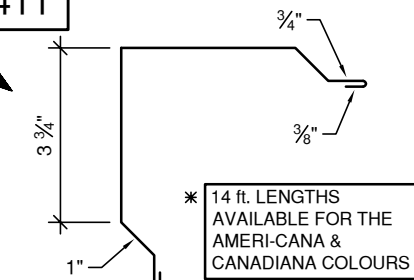

RAKE EDGE TRIM
(12" GIRTH) (10 or 14 ft. LENGTHS) *

* 14 ft. LENGTHS AVAILABLE FOR THE AMERI-CANA & CANADIANA COLOURS

#412

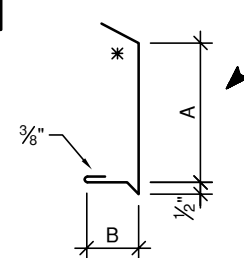

SPECIAL FASCIA
(A+B+3" = GIRTH) (B=MIN. 1 1/2") *SPECIFY PITCH

#414

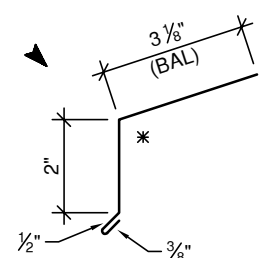

STEEL ROOFING DRIP EDGE
(6" GIRTH) * SPECIFY PITCH

FLASHINGS FOR EAVES & GABLE ENDS (continue)

#415

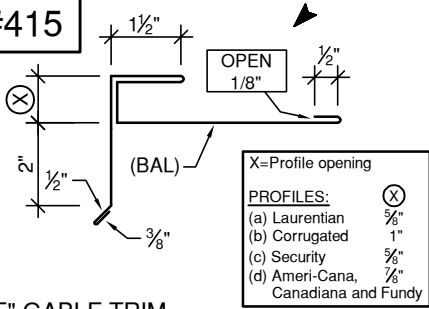

"F" GABLE TRIM
(12" GIRTH) (AVAILABLE IN 30G, 28G or 26G)

#416

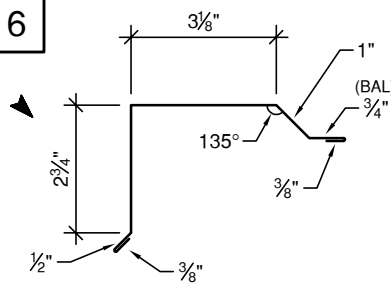

GABLE END CAP
(9" GIRTH)

#417

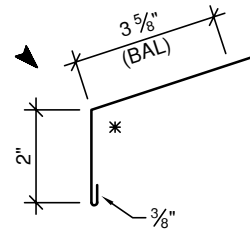

GUTTER APRON
(6" GIRTH)

* SPECIFY PITCH

"COLONIAL SIDING"

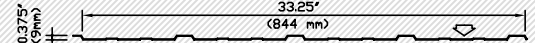

#501

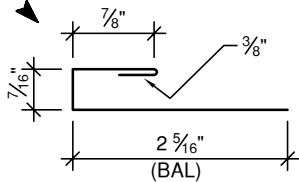

COLONIAL "J" TRIM
(4" GIRTH)

#502

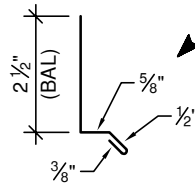

COLONIAL BASE FLASHING
(4" GIRTH)

#503

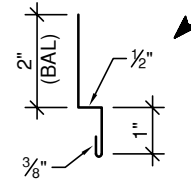

COLONIAL GABLE DIVIDER
(4" GIRTH)

#504

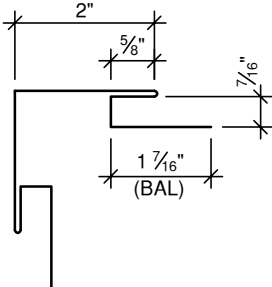

COLONIAL OUTSIDE CORNER
(9" GIRTH)

#505

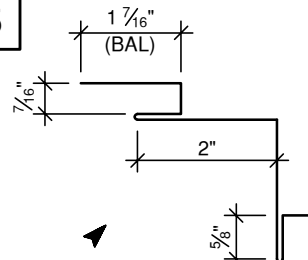

COLONIAL INSIDE CORNER
(9" GIRTH)

#518

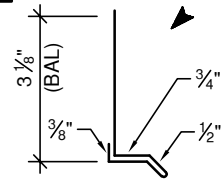

COLONIAL WINDOW & DOOR FLASHING
(6" GIRTH)

"COMMERCIAL RIB"



#601

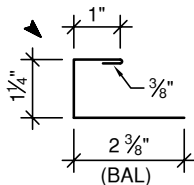

COMMERCIAL "J" TRIM
(5" GIRTH)

#602

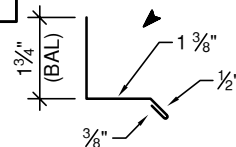

COMMERCIAL BASE FLASHING
(4" GIRTH)

"R-PANEL"

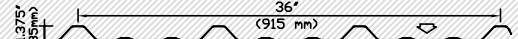

#R601

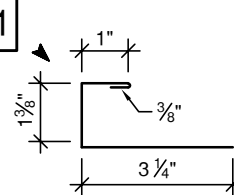

"J" TRIM
(6" GIRTH)

#R602

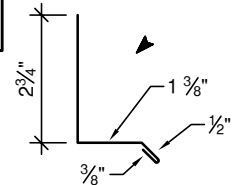

BASE FLASHING
(5" GIRTH)

#603

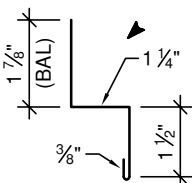

COMMERCIAL GABLE DIVIDER
(5" GIRTH)

#604

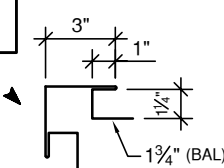

COMMERCIAL OUTSIDE CORNER
(14" GIRTH)

#R603

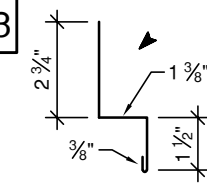

GABLE DIVIDER
(6" GIRTH)

#R604

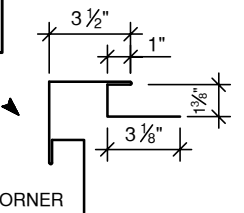

OUTSIDE CORNER
(18" GIRTH)

#605

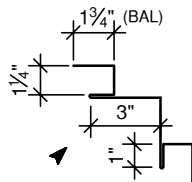

COMMERCIAL INSIDE CORNER
(14" GIRTH)

#610

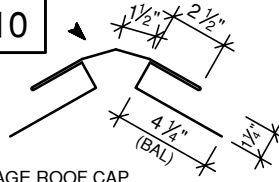

COTTAGE ROOF CAP
FOR COMMERCIAL RIB PROFILE
(24" GIRTH)

#R605

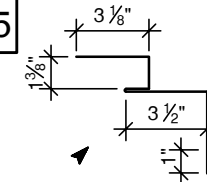

INSIDE CORNER
(18" GIRTH)

#R610

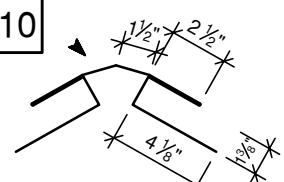

COTTAGE ROOF CAP
(24" GIRTH)

INDUSTRIAL PROFILES (100 SERIES)

NOTE:
THE "100 SERIES"
FLASHINGS & TRIMS MAY
BE USED WITH THE
FOLLOWING PROFILES.

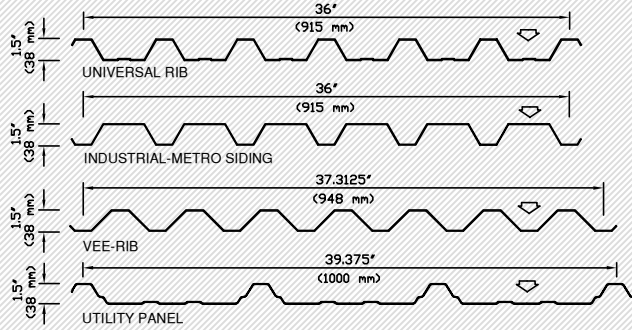

#101

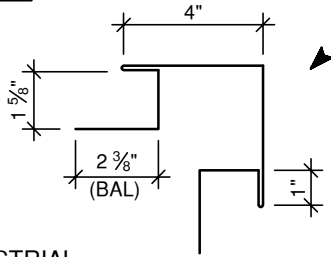

INDUSTRIAL
OUTSIDE CORNER
(18" GIRTH)

#102

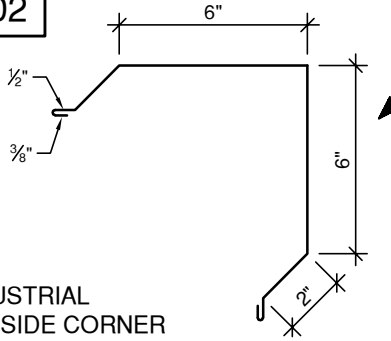

INDUSTRIAL
OUTSIDE CORNER
(18" GIRTH)

#103

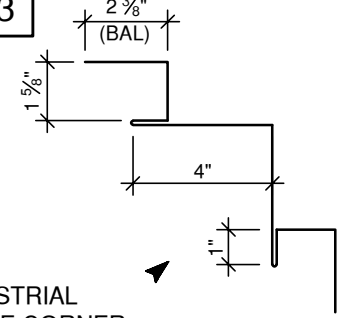

INDUSTRIAL
INSIDE CORNER
(18" GIRTH)

#104

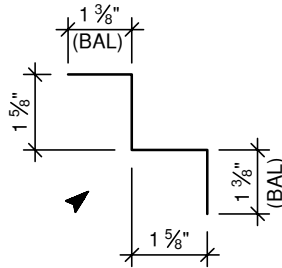

INDUSTRIAL
INSIDE CORNER
(6" GIRTH)

#105

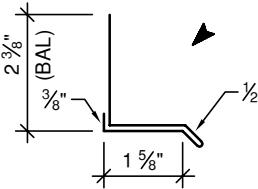

INDUSTRIAL
WINDOW & DOOR FLASHING
(7" GIRTH)

#106

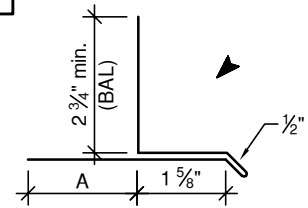

INDUSTRIAL
WINDOW & DOOR FLASHING
(A+7"=GIRTH)

#107

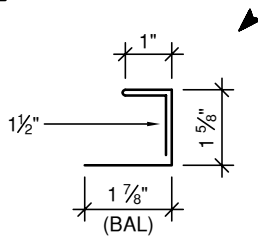

INDUSTRIAL "J" TRIM
(7" GIRTH)

#108

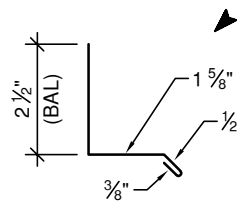

INDUSTRIAL BASE FLASHING
(5" GIRTH)

#109

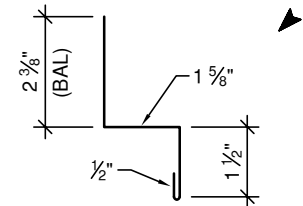

INDUSTRIAL GABLE DIVIDER
(6" GIRTH)

#110

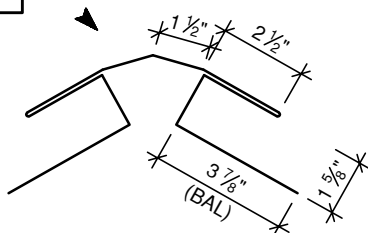

COTTAGE ROOF CAP
FOR INDUSTRIAL PROFILE
(24" GIRTH)

#111

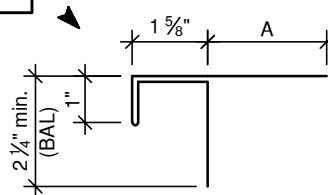

INDUSTRIAL DOOR & WINDOW JAMB
(A+7 1/2" = GIRTH)

"URBAN ACCENT" SERIES

NOTE: MOST OF THE "100 SERIES" INDUSTRIAL FLASHINGS & TRIMS MAY BE USED WITH THE URBAN ACCENT SERIES.

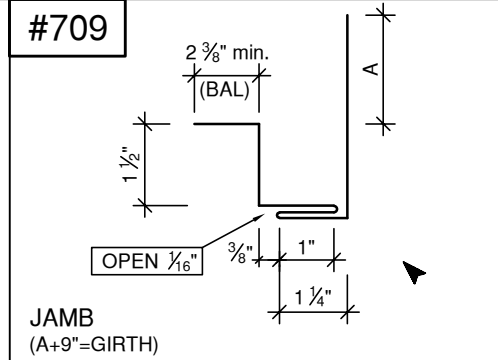
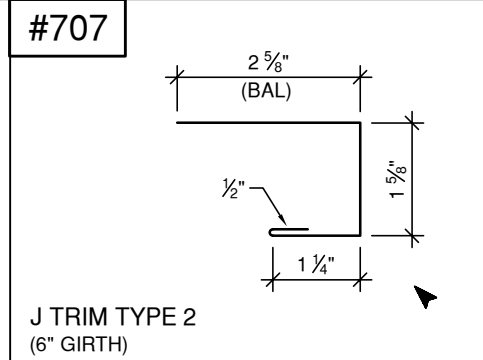
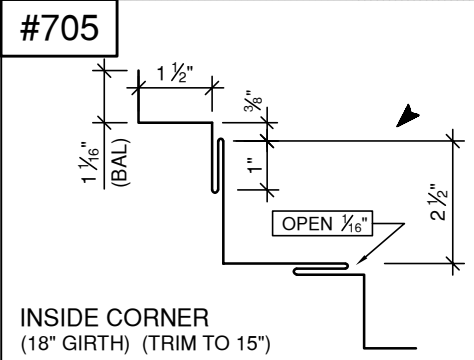
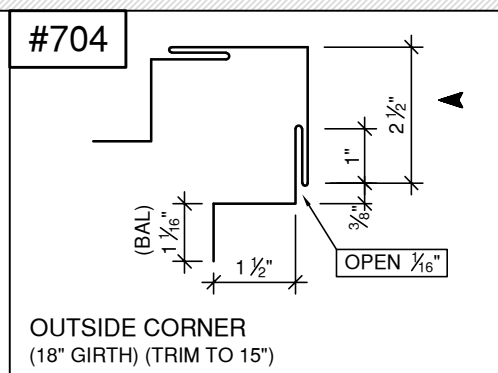
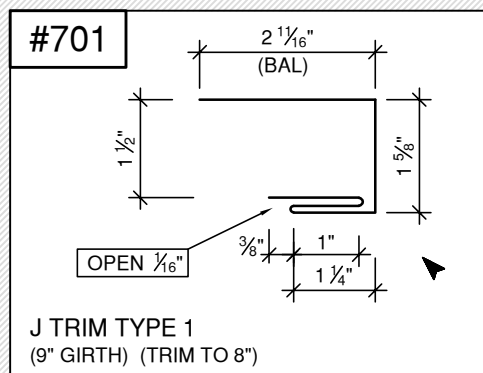
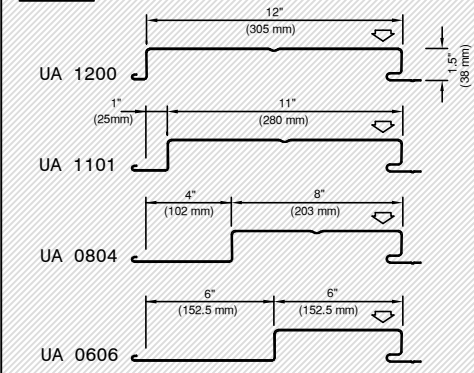

"HERITAGE SERIES" & "JUNIOR HF"

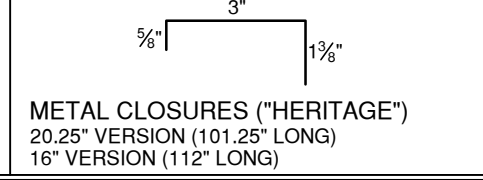
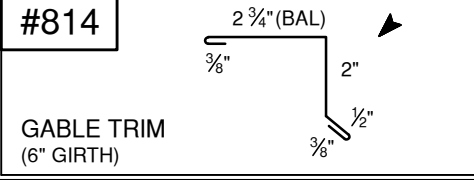
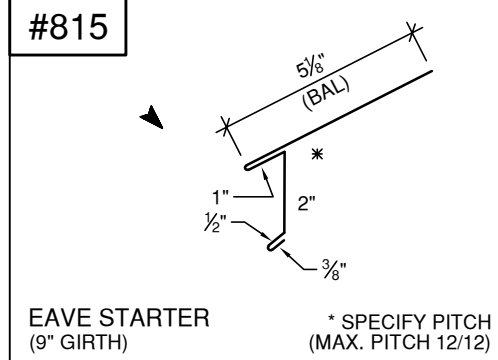
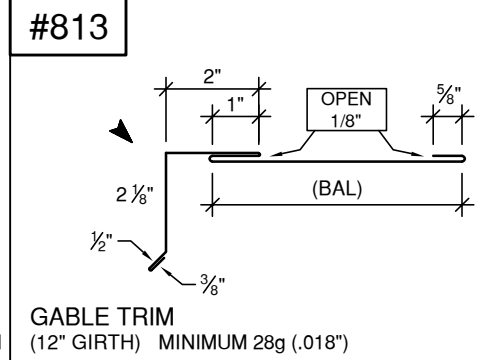
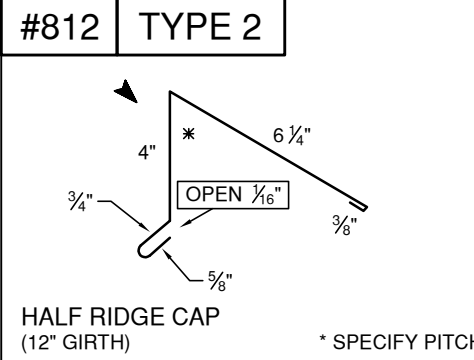
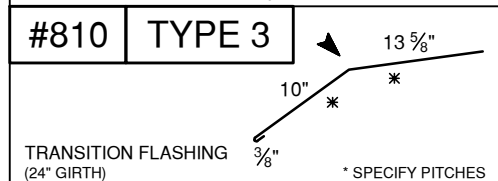
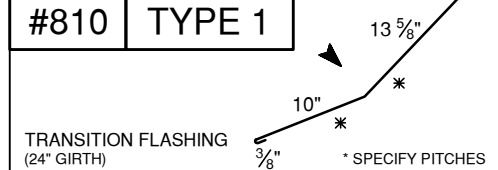
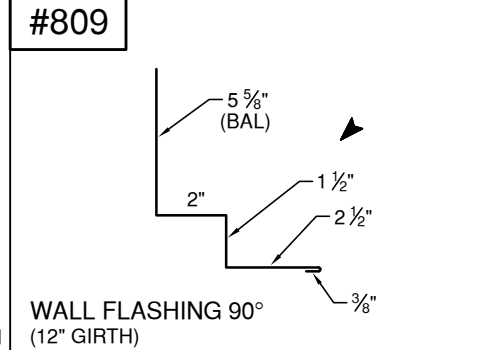
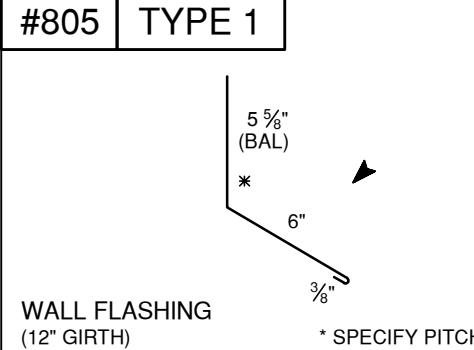
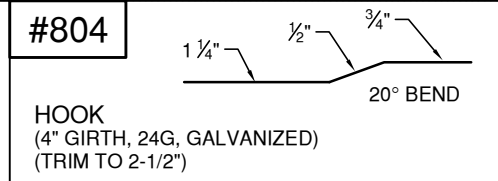
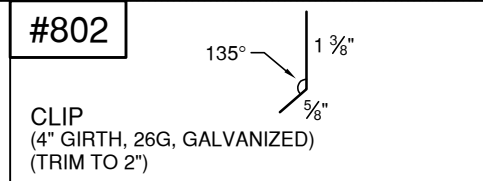

"HERITAGE SERIES"		"JUNIOR HF"		"HERITAGE SERIES"		"JUNIOR HF"	
#803 10'-0" LENGTHS, WILL BE CUT INTO 6" PIECES BY THE INSTALLER "CAP" (FOR THE OVERLAPS, END TO END) (4" GIRTH) (TRIM TO 3-11/16")	#803JR 10'-0" LENGTHS, WILL BE CUT INTO 6" PIECES BY THE INSTALLER "CAP" (FOR THE OVERLAPS, END TO END) (4" GIRTH) (TRIM TO 2-1/4")	#816 TRANSITION FLASHING (low to high pitch) (18" GIRTH) * SPECIFY PITCHES	#816JR TRANSITION FLASHING (low to high pitch) (18" GIRTH) * SPECIFY PITCHES	#806 WALL FLASHING WITH "J" OPENING (18" GIRTH) * SPECIFY PITCH (MAX. PITCH 12/12)	#806JR WALL FLASHING WITH "J" OPENING (18" GIRTH) * SPECIFY PITCH (MAX. PITCH 12/12)	#820 HALF RIDGE CAP (18" GIRTH) * SPECIFY PITCH (MAX. PITCH 12/12)	#820JR HALF RIDGE CAP (18" GIRTH) * SPECIFY PITCH (MAX. PITCH 12/12)
#808 VALLEY WITH 1/8" OPENINGS - GALVALUME (30" GIRTH) - PRE-PAINTED 10000 SERIES (28" GIRTH)	#808JR VALLEY WITH 1/8" OPENINGS (30" GIRTH)	#110 COTTAGE ROOF CAP FOR INDUSTRIAL PROFILE (24" GIRTH)	#110JR COTTAGE ROOF CAP FOR JUNIOR HF (24" GIRTH)	#811 TRANSITION FLASHING (high to low pitch) (A+B+12" = GIRTH) * SPECIFY PITCHES	#811JR TRANSITION FLASHING (high to low pitch) (A+B+12" = GIRTH) * SPECIFY PITCHES	#213 TYPE 1 GABLE END CAP FOR "HERITAGE" PROFILE (A+B+5 1/4" = GIRTH)	#213JR GABLE END CAP FOR JUNIOR HF (A+B+4 1/2" = GIRTH)
"WAKEFIELD BRIDGE" STEEL SHINGLES							
#905 TYPE 1 WALL FLASHING (12" GIRTH) * SPECIFY PITCH	#905 TYPE 2 TRANSITION FLASHING (12" GIRTH) * SPECIFY PITCHES	#905 TYPE 3 HIP FLASHING (12" GIRTH) * SPECIFY PITCHES	#906 WALL FLASHING (90°) (12" GIRTH)	#908 VALLEY (24" GIRTH)	#910 COTTAGE ROOF CAP (18" GIRTH)	#912 HALF RIDGE CAP (9" GIRTH) * SPECIFY PITCH	#916 SPECIAL "J" TRIM (5" GIRTH)
#408 STARTER FOR SHINGLES (5" GIRTH)	#815 EAVE STARTER (9" GIRTH) * SPECIFY PITCH (MAX. PITCH 12/12)						

"GALANTA" SIDING

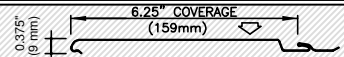

#G01

"J" TRIM
(4" GIRTH, 26g)

#G02

BASE FLASHING
(4" GIRTH, 26g)

#G03

STARTER
(4" GIRTH, 26g, GALVANIZED)

#G04

OUTSIDE CORNER
(8 3/8" GIRTH, 26g)

#G05

INSIDE CORNER
(8 3/8" GIRTH, 26g)

#G07

GABLE DIVIDER
(4" GIRTH, 26g)

#G08

PERFORATED "L" CLOSURE
(4" GIRTH)
(TRIM TO 2")

#G09

"Z" SUPPORT
(4" GIRTH, 26g, GALVANIZED)
(TRIM TO 3")

#G11

WINDOW & DOOR JAMB
(4 1/2" + A = GIRTH (8 3/8" max.), 26g)

#G12

WINDOW & DOOR FLASHING
(4" + A = GIRTH (8 3/8" max.), 26g)

#G17

SIDING / SOFFIT "F-J" TRIM
(8 3/8" GIRTH, 26g)

#G18

WINDOW & DOOR FLASHING
(4" GIRTH, 26g)

#G19A

VERTICAL DIVIDER
(Part "A")
(5" GIRTH, 26g)

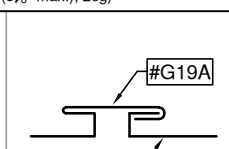

#G19B

VERTICAL DIVIDER
(Part "B")
(4" GIRTH, 26g) (TRIM TO 3")

VERTICAL DIVIDER
(Parts "A" & "B" assembled)

HEAVY GAUGE FIXATION

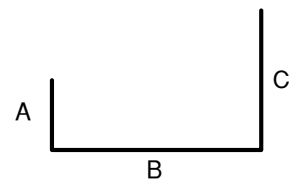

"U" CHANNEL
AVAILABLE IN 20 GA, 18 GA AND 16 GA.
GIRTHS AVAILABLE: 4", 5", 6", 7", 8", 9", 12", 18", 24"
(GIRTH = A + B + C)
NOTE: Measurements subject to machine capacities

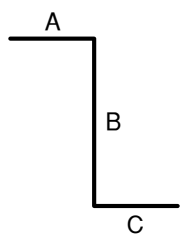

"Z" BAR
AVAILABLE IN 20 GA, 18 GA AND 16 GA.
GIRTHS AVAILABLE: 4", 5", 6", 7", 8", 9", 12", 18", 24"
(GIRTH = A + B + C)
A: min. 1"
B: min. 1"
C: min. 1"

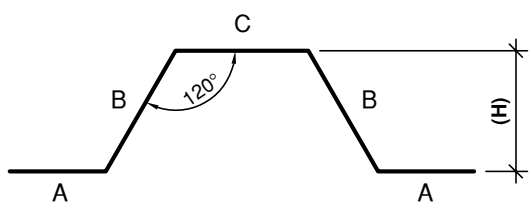

"OMEGA" BAR
AVAILABLE IN 20 GA, 18 GA AND 16 GA.
GIRTHS AVAILABLE: 4", 5", 6", 7", 8", 9", 12", 18", 24"
GIRTH = (A x 2) + (B x 2) + C
A: min. 1" ←
B: min. 1" ←
(H): Perpendicular height
NOTE: **B = (H) x 1.155**